

NLX2G08

Dual 2-Input AND Gate

The NLX2G08 is a high performance dual 2-input AND Gate operating from a 1.65 V to 5.5 V supply.

Features

- Extremely High Speed: t_{PD} 2.5 ns (typical) at $V_{CC} = 5$ V
- Designed for 1.65 V to 5.5 V V_{CC} Operation
- Over Voltage Tolerant Inputs
- LVTTL Compatible – Interface Capability With 5 V TTL Logic with $V_{CC} = 3$ V
- LVCMOS Compatible
- 24 mA Balanced Output Sink and Source Capability
- Near Zero Static Supply Current Substantially Reduces System Power Requirements
- Replacement for NC7WZ08
- Chip Complexity: FET = 124
- This is a Pb-Free Device

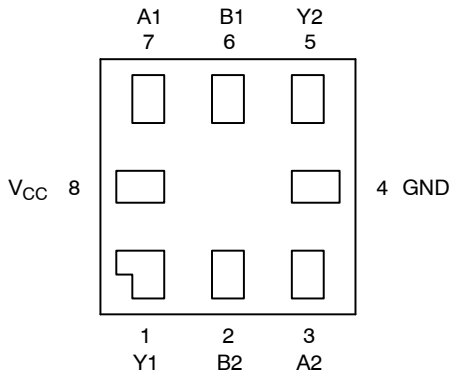

Figure 1. Pinout

PIN ASSIGNMENT

Pin	Function
1	Y1
2	B2
3	A2
4	GND
5	Y2
6	B1
7	A1
8	V_{CC}



ON Semiconductor®

<http://onsemi.com>



UQFN8
MU SUFFIX
CASE 523AN

MARKING DIAGRAM

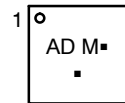

AD = Device Code
M = Date Code*
▪ = Pb-Free Package

(Note: Microdot may be in either location)

ORDERING INFORMATION

See detailed ordering and shipping information in the package dimensions section on page 4 of this data sheet.

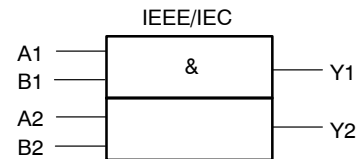

Figure 2. Logic Symbol

FUNCTION TABLE

$Y = AB$

Inputs		Output
A	B	Y
L	L	L
L	H	L
H	L	L
H	H	H

H = HIGH Logic Level
L = LOW Logic Level

NLX2G08

MAXIMUM RATINGS

Symbol	Parameter	Value	Unit
V _{CC}	DC Supply Voltage	-0.5 to +7.0	V
V _I	DC Input Voltage	-0.5 to +7.0	V
V _O	DC Output Voltage	-0.5 to V _{CC} + 0.5	V
I _{IK}	DC Input Diode Current V _I < GND	-50	mA
I _{OK}	DC Output Diode Current V _O < GND	-50	mA
I _O	DC Output Sink Current	±50	mA
I _{CC}	DC Supply Current per Supply Pin	±100	mA
I _{GND}	DC Ground Current per Ground Pin	±100	mA
T _{STG}	Storage Temperature Range	-65 to +150	°C
T _L	Lead Temperature, 1 mm from Case for 10 Seconds	260	°C
T _J	Junction Temperature under Bias	+150	°C
θ _{JA}	Thermal Resistance (Note 1)	TBD	°C/W
P _D	Power Dissipation in Still Air at 85°C	250	mW
MSL	Moisture Sensitivity	Level 1	
F _R	Flammability Rating Oxygen Index: 28 to 34	UL 94 V-0 @ 0.125 in	
V _{ESD}	ESD Withstand Voltage Human Body Model (Note 2) Machine Model (Note 3) Charged Device Model (Note 4)	> 2000 > 200 N/A	V
I _{Latch-Up}	Latch-Up Performance Above V _{CC} and Below GND at 85°C (Note 5)	±500	mA

Stresses exceeding Maximum Ratings may damage the device. Maximum Ratings are stress ratings only. Functional operation above the Recommended Operating Conditions is not implied. Extended exposure to stresses above the Recommended Operating Conditions may affect device reliability.

1. Measured with minimum pad spacing on an FR4 board, using 10 mm-by-1 inch, 2-ounce copper trace with no air flow.
2. Tested to EIA/JESD22-A114-A.
3. Tested to EIA/JESD22-A115-A.
4. Tested to JESD22-C101-A.
5. Tested to EIA/JESD78.

RECOMMENDED OPERATING CONDITIONS

Symbol	Parameter	Min	Max	Unit
V _{CC}	Supply Voltage Operating Data Retention Only	1.65 1.5	5.5 5.5	V
V _I	Input Voltage (Note 6)	0	5.5	V
V _O	Output Voltage (HIGH or LOW State)	0	V _{CC}	V
T _A	Operating Free-Air Temperature	-55	+125	°C
Δt/ΔV	Input Transition Rise or Fall Rate V _{CC} = 2.5 V ± 0.2 V V _{CC} = 3.0 V ± 0.3 V V _{CC} = 5.0 V ± 0.5 V	0 0 0	20 10 5	ns/V

6. Unused inputs may not be left open. All inputs must be tied to a high- or low-logic input voltage level.

NLX2G08

DC ELECTRICAL CHARACTERISTICS

Symbol	Parameter	Condition	V _{CC} (V)	T _A = 25°C			-55°C ≤ T _A ≤ 125°C		Unit
				Min	Typ	Max	Min	Max	
V _{IH}	High-Level Input Voltage		1.65 2.3 to 5.5	0.75 V _{CC} 0.7 V _{CC}			0.75 V _{CC} 0.7 V _{CC}		V
V _{IL}	Low-Level Input Voltage		1.65 2.3 to 5.5			0.25 V _{CC} 0.3 V _{CC}		0.25 0.3 V _{CC}	V
V _{OH}	High-Level Output Voltage V _{IN} = V _{IL} or V _{IH}	I _{OH} = 100 μA I _{OH} = -3 mA I _{OH} = -8 mA I _{OH} = -12 mA I _{OH} = -16 mA I _{OH} = -24 mA I _{OH} = -32 mA	1.65 to 5.5 165 2.3 2.7 3.0 3.0 4.5	V _{CC} - 0.1 1.29 1.9 2.2 2.4 2.5 3.8	V _{CC} 1.5 2.1 2.4 2.7 2.5 4.0		V _{CC} - 0.1 1.5 1.9 2.2 2.4 2.3 3.8		V
V _{OL}	Low-Level Output Voltage V _{IN} = V _{IH} or V _{OH}	I _{OL} = 100 μA I _{OL} = 3 mA I _{OL} = 8 mA I _{OL} = 12 mA I _{OL} = 16 mA I _{OL} = 24 mA I _{OL} = 32 mA	1.65 to 5.5 2.3 2.7 3.0 3.0 4.5		0.08 0.20 0.22 0.28 0.38 0.42	0.1 0.24 0.3 0.4 0.4 0.55 0.55		0.1 0.24 0.3 0.4 0.4 0.55 0.55	V
I _{IN}	Input Leakage Current	V _{IN} = V _{CC} or GND	0 to 5.5			±0.1		±1.0	μA
I _{CC}	Quiescent Supply Current	V _{IN} = V _{CC} or GND	5.5			1.0		10	μA

AC ELECTRICAL CHARACTERISTICS t_R = t_F = 3.0 ns

Symbol	Parameter	Condition	V _{CC} (V)	T _A = 25°C			-55°C ≤ T _A ≤ 125°C		Unit
				Min	Typ	Max	Min	Max	
t _{PLH} t _{PHL}	Propagation Delay (Figure 3 and 4)	R _L = 1 MΩ, C _L = 15 pF	1.8 ± 0.15	2.0	5.7	10.5	2.0	11.0	ns
2.5 ± 0.2			1.0	3.5	5.8	2.0	6.2		
3.3 ± 0.3		R _L = 1 MΩ, C _L = 15 pF	0.8	2.6	3.9	0.8	4.3		
		R _L = 500 Ω, C _L = 50 pF	1.2	3.2	4.8	1.2	5.2		
5.0 ± 0.5	R _L = 1 MΩ, C _L = 15 pF	0.5	1.9	3.1	0.5	3.3			
	R _L = 500 Ω, C _L = 50 pF	0.8	2.5	3.7	0.8	4.0			

CAPACITIVE CHARACTERISTICS

Symbol	Parameter	Condition	Typical	Unit
C _{IN}	Input Capacitance	V _{CC} = 5.5 V, V _I = 0 V or V _{CC}	4	pF
C _{PD}	Power Dissipation Capacitance (Note 7)	10 MHz, V _{CC} = 3.3 V, V _I = 0 V or V _{CC} 10 MHz, V _{CC} = 5.5 V, V _I = 0 V or V _{CC}	25 30	pF

7. C_{PD} is defined as the value of the internal equivalent capacitance which is calculated from the operating current consumption without load. Average operating current can be obtained by the equation: I_{CC(OPR)} = C_{PD} • V_{CC} • f_{in} + I_{CC}. C_{PD} is used to determine the no-load dynamic power consumption; P_D = C_{PD} • V_{CC}² • f_{in} + I_{CC} • V_{CC}.

NLX2G08

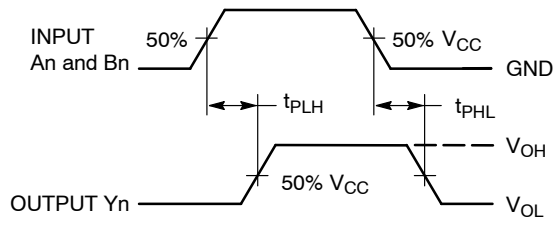
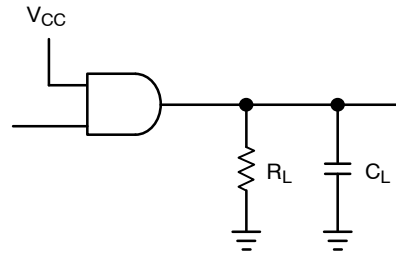

Figure 3. Switching Waveform



A 1-MHz square input wave is recommended for propagation delay tests.

Figure 4. Test Circuit

DEVICE ORDERING INFORMATION

Device Order Number	Package Type	Tape and Reel Size [†]
NLX2G08MUTCG	UQFN8 (Pb-Free)	3000 Unit / Tape & Reel

[†]For information on tape and reel specifications, including part orientation and tape sizes, please refer to our Tape and Reel Packaging Specifications Brochure, BRD8011/D.

NLX2G08

PACKAGE DIMENSIONS

UQFN8
MU SUFFIX
CASE 523AN-01
ISSUE O

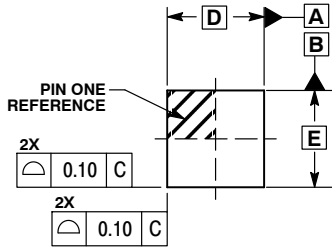

TOP VIEW

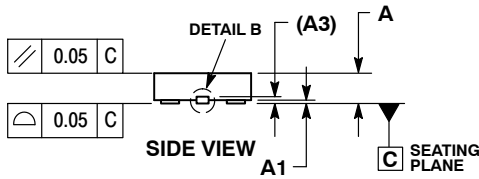

SIDE VIEW

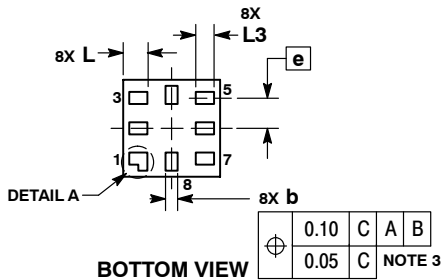

BOTTOM VIEW

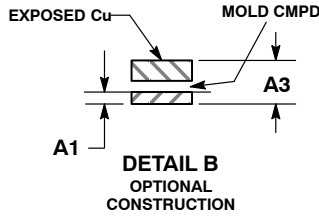

DETAIL B
OPTIONAL
CONSTRUCTION

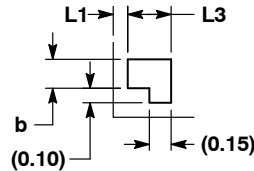

DETAIL A
OPTIONAL
CONSTRUCTION

NOTES:

1. DIMENSIONING AND TOLERANCING PER ASME Y14.5M, 1994.
2. CONTROLLING DIMENSION: MILLIMETERS.
3. DIMENSION b APPLIES TO PLATED TERMINAL AND IS MEASURED BETWEEN 0.15 AND 0.30 mm FROM THE TERMINAL TIP.

MILLIMETERS		
DIM	MIN	MAX
A	0.45	0.60
A1	0.00	0.05
A3	0.13	REF
b	0.15	0.25
D	1.60	BSC
E	1.60	BSC
e	0.50	BSC
L	0.35	0.45
L1	---	0.15
L3	0.25	0.35

SOLDERING FOOTPRINT*

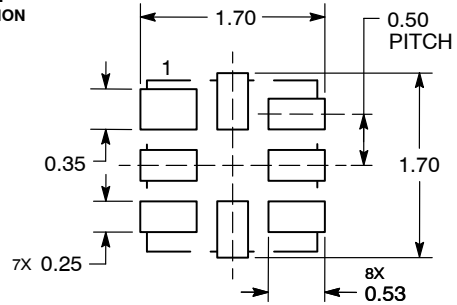

DIMENSIONS: MILLIMETERS

*For additional information on our Pb-Free strategy and soldering details, please download the ON Semiconductor Soldering and Mounting Techniques Reference Manual, SOLDERRM/D.

ON Semiconductor and are registered trademarks of Semiconductor Components Industries, LLC (SCILLC). SCILLC reserves the right to make changes without further notice to any products herein. SCILLC makes no warranty, representation or guarantee regarding the suitability of its products for any particular purpose, nor does SCILLC assume any liability arising out of the application or use of any product or circuit, and specifically disclaims any and all liability, including without limitation special, consequential or incidental damages. "Typical" parameters which may be provided in SCILLC data sheets and/or specifications can and do vary in different applications and actual performance may vary over time. All operating parameters, including "Typicals" must be validated for each customer application by customer's technical experts. SCILLC does not convey any license under its patent rights nor the rights of others. SCILLC products are not designed, intended, or authorized for use as components in systems intended for surgical implant into the body, or other applications intended to support or sustain life, or for any other application in which the failure of the SCILLC product could create a situation where personal injury or death may occur. Should Buyer purchase or use SCILLC products for any such unintended or unauthorized application, Buyer shall indemnify and hold SCILLC and its officers, employees, subsidiaries, affiliates, and distributors harmless against all claims, costs, damages, and expenses, and reasonable attorney fees arising out of, directly or indirectly, any claim of personal injury or death associated with such unintended or unauthorized use, even if such claim alleges that SCILLC was negligent regarding the design or manufacture of the part. SCILLC is an Equal Opportunity/Affirmative Action Employer. This literature is subject to all applicable copyright laws and is not for resale in any manner.

PUBLICATION ORDERING INFORMATION

LITERATURE FULFILLMENT:
Literature Distribution Center for ON Semiconductor
P.O. Box 5163, Denver, Colorado 80217 USA
Phone: 303-675-2175 or 800-344-3860 Toll Free USA/Canada
Fax: 303-675-2176 or 800-344-3867 Toll Free USA/Canada
Email: orderlit@onsemi.com

N. American Technical Support: 800-282-9855 Toll Free
USA/Canada
Europe, Middle East and Africa Technical Support:
Phone: 421 33 790 2910
Japan Customer Focus Center
Phone: 81-3-5773-3850

ON Semiconductor Website: www.onsemi.com

Order Literature: <http://www.onsemi.com/orderlit>

For additional information, please contact your local Sales Representative